

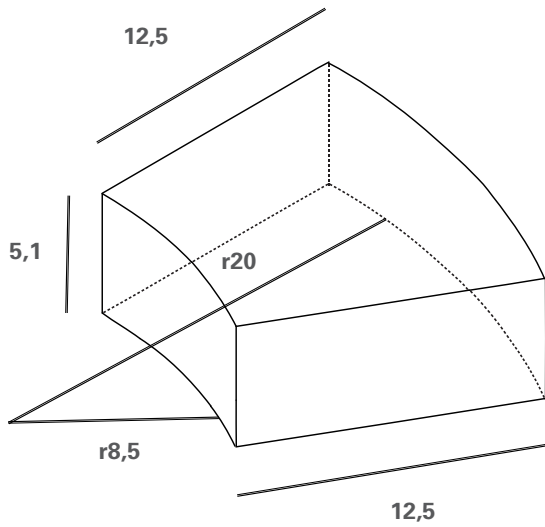

# 1/8 Colonna ø 40 cm | 1/8 Glass column ø 40 cm

L'essenza del vetro



**Voci di capitolato:** 1/8 Colonna ø 40 cm  
Mattonne di vetro pieno, interamente realizzato a mano secondo le normative ISO9001:200 (tipo mattonepoesia) presso gli stabilimenti di Resana Tv, idonei per realizzazioni di murature portanti, decorazione di interni dalle dimensioni nominali di 12,5 x 5,1 ø 40 cm, avente il peso unitario pari a circa 1,6 Kg, con sfumature interne di colori.

Tutte le superfici si possono lucidare, forare, tagliare, verniciare, sabbare e acidare.

L'altezza è soggetta ad una tolleranza del +- 2%

Il colore dei mattoni non è mai perfettamente uguale, pertanto le variazioni sono da considerarsi una caratteristica tecnica del prodotto.

Eventuali segni sulle superfici sono da considerarsi una caratteristica del prodotto fatto a mano.

**Specification data:** 1/8 Glass Column ø 40 cm  
Solid glass brick, entirely made by hand according to the ISO9001:200 (type mattonepoesia) in the factories of Resana TV, suitable for achievements of masonry load-bearing walls, interior decoration with the nominal size of 12,5 x 5,1 ø 40 cm, with the weight unit equal to 1,6 Kg, with internal nuances of colours. All surfaces can be polished, drilled, cut, painted, etched.

The height is subject to a tolerance of +- 2%

Due to the hand made nature of the brick, the colour tone and composition of each brick is unique and may vary slightly from piece to piece.

Signs on the surfaces are considered as a characteristic of the product made by hand.

**A** Collezione Neutral  
Neutral

**B** Collezione Special  
Bubble Silver Glitter\* Gold Glitter\*

**C** Collezione Cloud  
Cloud White Cloud Green Cloud Orange Cloud Pink  
Cloud Amber Cloud Skyblue Cloud Dark Blue Cloud Red

**D** Collezione Precious Stones  
Smoky Quartz Tourmaline Quartz Golden Amber  
Blue Sapphire Aquamarine Green Peridot



## 1/8 Colonna ø 40 cm | 1/8 Glass column ø 40 cm

### DATI TECNICI

<b>Resistenza alla compressione (28g)</b> <i>Compression resistance</i>	2522,45 kg/cm <sup>2</sup>
<b>Conduttività termica</b> <i>Thermal conductivity</i>	W/m*K22°C 0,974
<b>Dilatazione termica</b> <i>Thermal dilation</i>	$\alpha(C-1)(25-450^{\circ}C) 11,0 \times 10^{-6}$
<b>Durezza</b> <i>Hardness</i>	Vickers 520 Hv 0,5
<b>Resistenza al fuoco</b> <i>Fire resistance</i>	REI 60
<b>Resistenza ai proiettili</b> <i>Bulletproof</i>	Magnum 357

Per una corretta installazione vedi istruzioni per la posa.  
Per il limiti delle applicazioni consultare l'azienda.

*For proper installation follow the instructions data.  
Limits applications consult the company.*

### ALCUNE TIPOLOGIE DI POSA TRADIZIONALE | SOME TRADITIONAL POSES

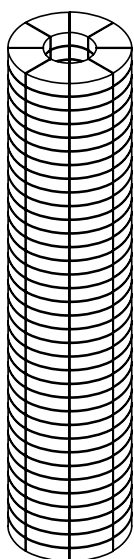

**A•** Ortogonale con fuga da 0,8-0,4-0,1\* cm  
*Orthogonal with joint of 0,8-0,4-0,1\* cm*

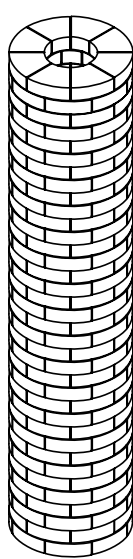

**B•** Sfalsata con fuga da 0,8-0,4-0,1\* cm  
*Stagger with joint of 0,8-0,4-0,1\* cm*

### ALCUNE TIPOLOGIE DI INSERTI | SOME INSERTS



**C•** Inserti da parete con fuga da 0,8-0,4-0,1\* cm  
*Inserts on wall with joint of 0,8-0,4-0,1\* cm*

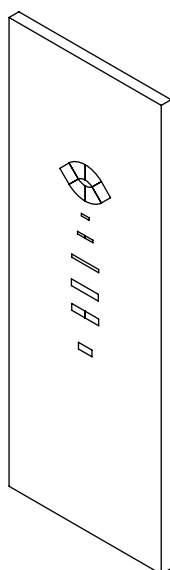

**D•** Inserti da parete con fuga da 0,8-0,4-0,1\* cm  
*Inserts on wall with joint of 0,8-0,4-0,1\* cm*

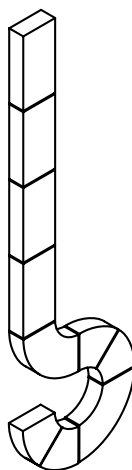

**E•** Inserti da parete con fuga da 0,8-0,4-0,1\* cm  
*Inserts on wall with joint of 0,8-0,4-0,1\* cm*

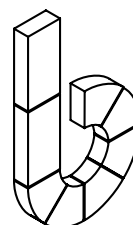

**F•** Inserti da parete con fuga da 0,8-0,4-0,1\* cm  
*Inserts on wall with joint of 0,8-0,4-0,1\* cm*

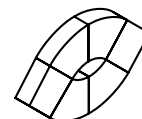

**G•** Inserti da parete con fuga da 0,8-0,4-0,1\* cm  
*Inserts on wall with joint of 0,8-0,4-0,1\* cm*